

The Revvity logo is displayed in white lowercase letters on a black background. The background of the top half of the cover features a cluster of colorful, translucent spheres in shades of yellow, green, and purple, resembling a molecular or biological structure.

revvity

USER MANUAL

Bead Ruptor™ 96+

Version: D

Document Number: 03-298

Date: October 2024

Data herein has been verified and validated. It is believed adequate for the intended use of the instrument. If the instrument or procedures are used for purposes over and above the capabilities specified herein, confirmation of the validity and suitability should be obtained; otherwise Revvity does not guarantee results and assumes no obligation or liability. This publication is not a license to operate under, or a recommendation to infringe upon, any process patents.

This product is warranted to be free from defects in material and workmanship for a period of ONE YEAR from the date of delivery. Revvity will repair or replace and return free of charge any part which is returned to its factory within said period, transportation prepaid by user, and which is found upon inspection to have been defective in materials or workmanship. This warranty does not include normal wear from use; it does not apply to any instrument or parts which have been altered by anyone other than an employee of Revvity nor to any instrument which has been damaged through accident, negligence, failure to follow operating instructions, the use of electric currents or circuits other than those specified on the plate affixed to the instrument, misuse, or abuse. Revvity reserves the right to change, alter, modify, or improve any of its instruments without any obligation whatever to make corresponding changes to any instrument previously sold or shipped.

THE FORGOING OBLIGATION IS IN LIEU OF ALL OBLIGATIONS AND LIABILITIES INCLUDING NEGLIGENCE AND ALL WARRANTIES OF MERCHANTABILITY OR OTHERWISE, EXPRESSED OR IMPLIED IN FACT OR BY LAW, AND STATE OUR ENTIRE AND EXCLUSIVE LIABILITY AND BUYERS EXCLUSIVE REMEDY FOR ANY CLAIM OF DAMAGES IN CONNECTION WITH THE SALE OR FURNISHING OF GOODS OR PARTS, THEIR DESIGN, SUITABILITY FOR USE, INSTALLATION, OR OPERATION. REVVITY WILL IN NO EVENT BE LIABLE FOR ANY SPECIAL OR CONSEQUENTIAL DAMAGES WHATSOEVER, AND THEIR LIABILITY UNDER NO CIRCUMSTANCES WILL EXCEED THE CONTRACT PRICE FOR THE GOODS FOR WHICH LIABILITY IS CLAIMED.

This product has been engineered for safety; however, basic safety precautions and common sense must always be demonstrated when using any electrical product.

- Use this product only for its intended purpose.
- Keep this product away from heated surfaces.
- **DO NOT** attempt to modify any part of this product.
- **DO NOT** allow the machine to be submerged in any liquid.
- **DO NOT** use in any setting other than an indoor laboratory.
- **DO NOT** use attachments not recommended by the manufacturer.
- **DO NOT** operate the product if it is damaged in any way.
- **DO NOT** operate the product with the safety ground disconnected.
- **DO NOT** modify the plug or cord that is provided.

WARNING: Reduce the risk of unintentional starting; make sure the machine is OFF before plugging into a power supply.

WARNING: Damaged or worn power cords should be repaired or replaced immediately by a qualified electrician.

WARNING: Improper connection of the equipment can result in a risk of electric shock.

WARNING: The processing chamber of the Bead Ruptor™ 96+ homogenizer is enclosed by a strong covering lid.

Starting of the instrument is possible only with the lid closed. If the lid is open, message "Er Lid oPE Er" appears on display, when you press the START button.

When message "Er Lid oPE Er" appears on display, you have to close the lid and clear the message by pressing the START button. Then you can start the instrument by pressing the START button again.

If you open the lid during the operation, the instrument stops rapidly and message "Er Lid Err Er" appears on display. When message "Er Lid Err Er" appears on display, you can't start the instrument again by pressing the START button. You have to turn the main switch OFF and then ON again, to clear the message and use the instrument again.

Milling Jar Requirements

WARNING: The sample quantity must not be less than 25 % of the milling jar capacity. The milling balls may otherwise damage the milling jars. The milling jars and milling balls must be the same material. Otherwise the milling jar could be damaged.

WARNING: The instrument must be balanced prior to operation. Do not operate the instrument with only one milling jar or one well plate adapter installed in a single milling jar holder. Both milling jar holders must have either a milling jar (filled with equivalent mass) or well plate adapters. If not balanced damage to the lid is possible.

Copyright

This manual is published by Revvity 935 Cobb Place Blvd, Kennesaw, GA 30144 USA. Copyright Revvity, Inc. All rights reserved, including but not limited to those rights to reproduce this publication or parts thereof. Reproduction of this publication or parts thereof, or the products it describes, by any means or in any form is expressly prohibited without the written permission of Revvity.

Trademarks

Revvity is a registered trademark of Revvity. All other trademarks are the property of their respective owners.

Proper Equipment Operation

To reduce the risk of electric shock, do not remove the cover. No user serviceable parts are inside. Refer to qualified service personnel if help is required.

Use this product only in the manner described in this manual. If the equipment is used in a manner not specified by the manufacturer, the protection provided by the equipment may be impaired.

Cleaning

Follow internal laboratory process for cleaning and decontamination using 70% ethanol followed by a disinfecting wipe, then a final rinse with ethanol.

Preventative Maintenance

Normal use: 12 month interval.

Heavy use may require a 6 month interval.

Operating Environment

5°C to 40°C / 41°F to 104°F, Humidity: 5% to 85% RH. Internal use only

Electrical Supply

100-230V, 50/60 Hz

FCC

This device complies with part 15 of the FCC (United States Federal Communications Commission) Rules.

Operation is subject to the following two conditions:

- This device may not cause harmful interference, and
- This device must accept any interference received, including interference that may cause undesired operation.

CE/UKCA













This device complies with all CE and UKCA rules and requirements.

Changes or modifications to this equipment not expressly approved by the party responsible for compliance could void the user's authority to operate the equipment.

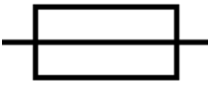
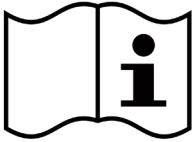
Table of Contents

Table of Symbols.....	5
Safety Information	6
Intended Use	7
Specifications.....	7
Installation	8
Unpacking	8
Installation Location	8
Connecting the Power Cord	8
Instructions for Use	9
Overall View.....	9
Control Panel Description.....	10
Knob and Button Functions	11
Turning ON the Instrument.....	11
Opening and Closing the Lid.....	12
Opening and Closing Milling Jars.....	12
Filling and Inserting Milling Jars	12
Inserting Well Plate Adapters.....	14
Setting the Homogenization Frequency.....	15
Setting the Run Time	15
Program Setting.....	15
Cycler Setting	17
Starting and Stopping the Unit	21
Operational Best Practices.....	22
Recommended Jar Filling Levels.....	22
Recommended Frequencies and Timing.....	22
Cooling with Liquid Nitrogen	22
Milling Jar Usage and Washer Replacement	23
Troubleshooting.....	24
Maintenance.....	25
Cleaning the Instrument	25
Cleaning the Milling Jars and Balls.....	25
Replacing Fuses.....	25
Accessories	26
Appendix.....	26
Equipment Decontamination	26
Transport and Storage	26
Equipment Disposal.....	26

Table of Symbols

Symbol	Description	Symbol	Description
	Caution. Refer to the User documentation (ISO 7000-0434B)		On (power). (IEC 60417-5007)
	Hazardous voltage; risk of electric shock. (IEC 60417-6042)		Off (power). (IEC 60417-5008)
	Warning; Hot surface		Warning; Hand Crush
	Fuse. (IEC 60417-5016)		Consult Instructions for Use. (ISO 7000-1641)
	WEEE symbol (EN50419:2005)		CE Compliance Mark
 RoHS	RoHS 2002/95/EC, 2011/65/EU, 2015/863 Compliant		FCC Compliance
	UKCA Certification Mark		

Safety Information

Before using the instrument, make sure to read and understand this manual thoroughly. Keep the manual close to the instrument, easily accessible to all the users. Improper operation can cause injury to persons or damage to the equipment.

Claims for damages in any form whatsoever, for injury to persons or damage to the instrument, caused through non-observance of the following safety instructions, are excluded.



Use according to the intended purpose

Do not make any alterations to the instrument and use only approved spare parts and accessories. Otherwise the Declaration of Conformity will lose its validity and this will also lead to the loss of any guarantee claims.

Transport

Do not knock, shake or throw the Bead Ruptor™ 96+ during transport. Otherwise the electronic and mechanical components may be damaged.

Packing material

Please keep the packing material for the duration of the guarantee period. In case of a complaint and return of the instrument in unsuitable packing material, your guarantee claim will be lost.

Temperature variations

If the Bead Ruptor™ 96+ is subjected to high temperature variations, protect it against condensed water. Otherwise the electronic components may be damaged.

Ambient temperature

If the temperature drops below 5°C or exceeds 40°C, electronic and mechanical components can be damaged. Performance can be changed to an unknown extent.

Atmospheric humidity

If the humidity exceeds 85%, electronic and mechanical components can be damaged. Performance can be changed to an unknown extent.

Inserting milling jars

Ensure that the milling jars are inserted correctly in the milling jar holder. Otherwise they can be damaged, when starting the instrument. Both milling positions must always be used. Otherwise this will cause considerable unbalance.

Materials

Observe the relevant regulations and directives for handling chemicals and hazardous materials. Milling of materials, which give a risk of fire or explosion, is prohibited.

Repair

For your own safety, repairs must be carried out only by authorized service technicians.



Electrical connection

If the values for the mains power supply on the name plate are not observed, the electrical and mechanical components may be damaged.

Cleaning

Do not clean the Bead Ruptor™ 96+ under running water. Danger to life through electric shock.



Removing and opening hot milling jars

When removing and opening hot milling jars, always wear protective gloves. There is a danger of burning the hands.



Opening and closing of the lid

When opening and closing the lid, be careful not to drop it uncontrollably, as fingers and hands may get injured if they are in the position where the lid closes.

Intended Use

The Bead Ruptor™ 96+ is a laboratory device, which is intended for the milling and homogenizing of soft, fibrous, hard and brittle materials in the dry and wet state. It is used for fast, super fine milling of two or more samples simultaneously.

The closed milling system guarantees complete recovery of the samples. Owing to the extremely short milling time and the high final fineness of the milled material, the Bead Ruptor™ 96+ is also ideally suitable for sample preparation for all spectral analyses. Final finenesses of down to 1 µm can be achieved, depending on the milling time and the specific properties of the sample material.

Specifications

Part Number	27-0003 - 120V 27-0004 - 220V
Power supply	120V ± 10%, 50/60Hz 220V ± 10%, 50/60Hz
Rated power	200 Watts
Fuses	2 x 3.15AT 250V (230V) 2 x 6.3AT 250V (120V)
Homogenization frequency regulation	Digital, from 3 to 30 Hz (180 - 1800 min ⁻¹), in 0.1 Hz steps (from 3.0 to 9.9 Hz) and 1 Hz steps (from 10 to 30 Hz)
Timer	10 sec - 99 min 50 sec timer HOLD function, in 1 sec steps (below 10 min), or 10 sec steps (above 10 min)
Maximum volume of milling jars	50 mL per jar
Dimensions (W x D x H)	W: 15.8" (40.0 cm), D: 18.5" (47.1 cm), H: 10.1" (25.6 cm), 22.4" (57 cm) with lid open)
Weight	100 lbs. (45.5 kg)
Noise Emission (without milling balls)	70 dB(A)
Ambient temperature	5 - 40°C
Relative humidity	Up to 85% RH, non-condensing
Altitude	Up to 2000 m
Warranty	1 Year
Standards Approval	CE and UKCA Approved

Installation

Unpacking

The weight of the instrument is 45.5 kg. To prevent possible injuries, at least two people should lift and carry the instrument by holding it at the bottom from opposite sides.

Before the installation, carefully examine the delivery for possible damage or missing parts. Open the box and take the instrument out of the box. Check that the instrument has not been visibly damaged during the transport.

Please keep the packing material for the duration of the guarantee period. In case of a complaint and return of the instrument in unsuitable packing material, your guarantee claim will be lost.

Check that the mains cord is compatible with the local standard.

If any kind of damage occurred during transport, immediately make a complaint to the carrier. Any incorrect delivery or missing parts should be reported to the distributor.

The Bead Ruptor™ 96+ Homogenizer consists of the following:

Description	Quantity
Bead Ruptor™ 96+ Homogenizer Assembly	1
Milling Wrench	2
Power Cord	1
Spare Fuse	1
User Manual	1

Table 1. Bead Ruptor 96+ box contents.

Installation Location

When selecting the right place for the instrument, please consider the following:

- Put the device on smooth, horizontal and stable place.
- Leave enough space beyond the device for normal air circulation, min. 10 cm.
- Leave enough space around the device, that you will easy control and maintain it.
- Avoid places, where the possibility of shocks and vibrations exists.
- Don't use the device in surroundings, where there are fast temperature and humidity changes. Also avoid places exposed to direct sunlight and places nearby heating devices.

NOTE: The instrument should not be placed so, that it is difficult to pull out the cord plug from mains power supply.

Connecting the Power Cord

The correct voltage and frequency for the Bead Ruptor™ 96+ are given on the name plate. Ensure that these values correspond to the available power supply system.

Fit one end of the power cord, included in the delivery, into the mains socket on the instrument. Connect the other end of the cord to a grounded wall socket.

To avoid interference from noise, surges and spikes, a dedicated line is preferred. If no such line is available, avoid lines to which powerful electric motors, refrigerators and similar devices are connected.

The power can be turned on and off by the main switch, located on the right side of the housing of the instrument. Light in the switch indicates when the power is on.

Instructions for Use

Overall View

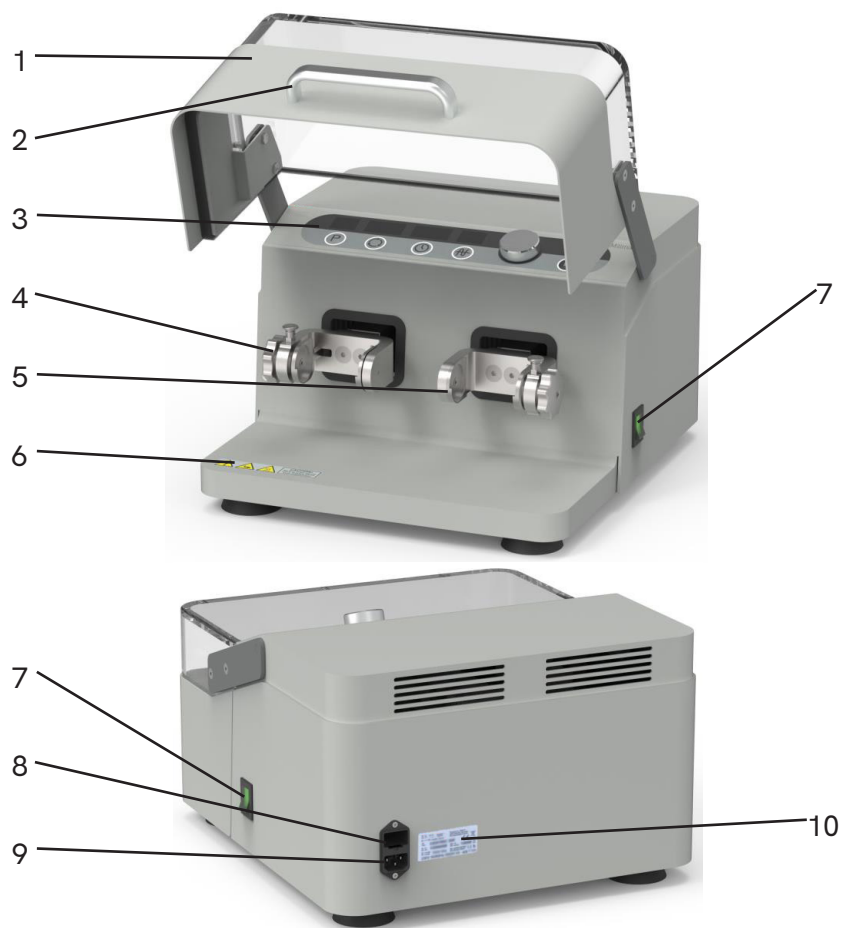

Figure 1. Overall view of Bead Ruptor 96+.

Position	Description	Function
1	Lid	Closes the milling chamber
2	Lid handle	For opening and closing the lid
3	Control panel with display	Setting of homogenization frequency, time, cycler, programs and starting/stopping the instrument.
4	Milling jar holder - left	Holds the milling jar
5	Milling jar holder - right	Holds the milling jar
6	Warning symbols	Indicates potential risks and hazards
7	Main switch	For switching the Bead Ruptor™ 96+ on and off
8	Fuse compartment	Contains two fuses
9	Mains socket	Connection for power cord to instrument
10	Name label	Instrument data

Table 2. Description and function of positions 1-10 on the Bead Ruptor 96+ overall view.

Control Panel Description

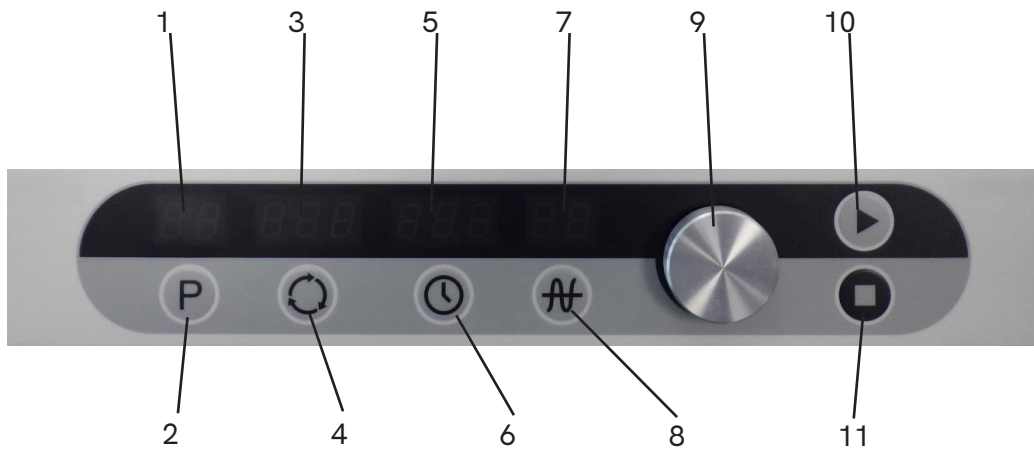









Figure 2. Bead Ruptor 96+ control panel view.

1	Program display
2	Program button
3	Cycler display
4	Cycler button
5	Time display
6	Time button
7	Homogenization frequency display
8	Frequency button
9	Adjustment knob
10	Start button
11	Stop button

Table 3. Description and function of positions 1-11 on the Bead Ruptor 96+ control panel view.

Knob and Button Functions

	<p>By rotating the knob, you change the values of the parameters on display. By rotating the knob clockwise, the value increases, and by rotating it counterclockwise, the value decreases. By pressing on the knob, you confirm the new value of the parameter.</p> <p>If you rotate the knob fast, then values on display change quickly.</p>
	<p>By pressing this button, you can set the programs. The button lights up. Select a program by rotating the knob and confirm it by pressing on the knob. The button light will then turn off. If you want to change the values of parameters of an existing program, set the values of time and frequency as described below, when this button is lit. You can't use cycler in the programs.</p>
	<p>By pressing this button, you can set the cycler. The button lights up. By rotating and pressing the knob and pressing this button select the cycle program, number of cycles and sub parameters per cycle.</p>
	<p>By pressing this button, you can set the run time. The button lights up. Set new time by rotating the knob and confirm it by pressing on the knob. The button light will then turn off.</p>
	<p>By pressing this button, you can set the homogenization frequency. The button lights up. Set new frequency by rotating the knob and confirm it by pressing on the knob. The button light will then turn off.</p>
	<p>By pressing this button, you start the run of the instrument. The button lights up and thus indicates that the instrument is running. At the end of the set running time or manual stopping of the instrument, the instrument stops and the button light turns off. The next run is possible when the instrument stops completely.</p>
	<p>By pressing this button, you stop the run of the instrument. The button lights up and thus indicates that the instrument is stopping. Until the instrument stops completely, the START button remains lit, thus indicating that the instrument hasn't stopped yet.</p> <p>By pressing the STOP button in the procedure of setting the programs or cycler, you cancel the procedure and return to stand-by mode without confirming the data.</p>

Turning ON the Instrument

Turn on the main switch, located on the right side of the housing. Light in the switch indicates when the power is on.

All segments (eights) are displayed on all displays at first. Then all the buttons light up and instrument model (MM 30) is displayed. Then program version (VER X.XX) is displayed. Then the values of operation parameters are displayed.

The values of operation parameters (programs, cycler, run time, homogenization frequency) are automatically set to the last used values.

Opening and Closing the Lid

The lid is equipped with a soft opening and closing mechanism that prevents uncontrolled falling of the lid and reduces the possibility of injury to the user.

When opening the lid, firmly hold the lid handle and carefully lift it to the final position, so that it stands independently on the upper side of the instrument.

When closing the lid, firmly hold the lid handle and slowly lower it into the closed position.

Opening and Closing Milling Jars

- Obtain two milling jar wrenches
- Place one milling jar wrench on each end of the milling jar
- Turn one wrench counterclockwise while securing the other wrench from moving to loosen jar seal.
- Carefully separate the jar halves.

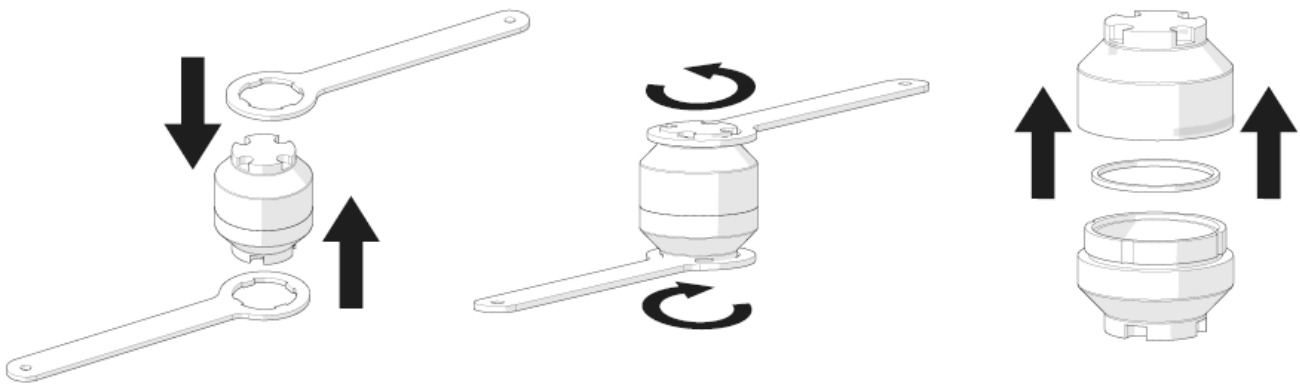

Figure 3. Schematic showing how to open and close milling jars.

Filling and Inserting Milling Jars

The optimum milling jar filling is as a rule 1/3 of the milling jar volume. Exceptions to this are voluminous materials, such as wool, leaves, grasses and suchlike. In these cases a filling level of 70-80 % is necessary.

- Fill milling jar with material to be milled. Ensure the two-white o-rings are in place prior to sealing jars.
- Place the sealed milling jars, filled with the material to be milled and milling balls, into the centering points (A) of the clamping devices and clamp firmly.

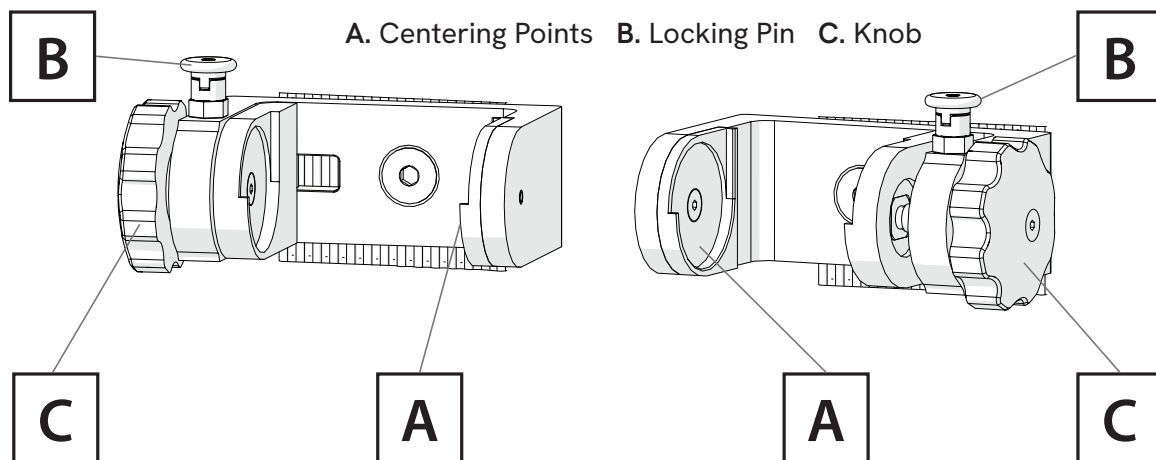

Figure 4. View of left and right milling jar arms.

Filling and Inserting Milling Jars (continued)

- Lift the locking pin (B) upwards from the groove and turn it 90° in any direction to unlock.
- Turn the knob (C) counter clockwise all the way to maximize clamping range.
- Turn locking pin (B) 90° and allow it to reengage in locked position.
- Place the milling jar into the milling jar arm and seat it into centering points (A).
- Gently turn knob (C) clockwise until the milling jar fits firmly inside the holder, with no give. The locking pin (B) will move up and down as you tighten the knob (C).
- To remove the milling jar, lift the locking pin (B) and turn it 90° to unlock and turn the knob (C) counter clockwise to loosen. If locking pin (B) is difficult to release turn knob (C) slightly clockwise to release locking pin (B) tension.

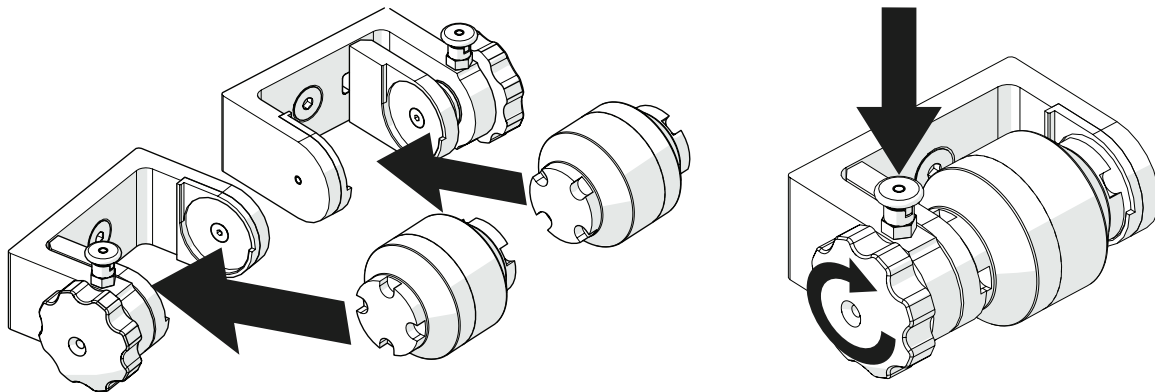

Figure 5. Showing how to insert milling jars.

WARNING: Always include an O-Ring when a Milling Jar is assembled to run.

WARNING: Do not force locking pin (B) open. Turn knob (C) clockwise to release.

WARNING: When removing hot or cryogenically cooled milling jars always wear protective gloves.

WARNING: It is unlawful to mill flammable or explosive material

WARNING: Milling jars must be inserted and aligned with centering points (A). If this is not done jars may be ejected during processing.

Inserting Well Plate Adapters

- Bead Ruptor™ 96+ Homogenizer well plate adapters (Cat # 27-101) can hold 1 x 2 mL deep well plate, 2 x 1 mL deep well plates or 3 x standard well plates per processing arm.
- 96 well 2D barcode storage tube adapters (Cat # 27-107, 27-108) can hold 1 x 1.1 mL or 1 x 1.4 mL plates per processing arm.
- Place samples and beads in the well plate.
- Fully seal the well plate with well plate mat. Care must be taken to ensure the well plate is properly sealed.
- A silicon mat is recommended.
- If processing multiple well plates, stack the well plates bottom to top.
- Place the well plate adapters on the top and bottom of the well plate stack. Ensure the adapter extensions are aligned.
- Lift the locking pin (B) upwards from the groove and turn it 90° in any direction to unlock.
- Turn the knob (C) counter clockwise all the way to maximize clamping range.
- Turn locking pin (B) 90° and allow it to reengage in locked position.
- Place the well plate adapter into the milling jar arm and seat it into centering points (A).
- Gently turn knob (C) clockwise until the well plate adapter fits firmly inside the holder, with no give. The locking pin (B) will move up and down as you tighten the knob (C).
- To remove the well plates, lift the locking pin (B) and turn it 90° to unlock and turn the knob (C) counter clockwise to loosen. If locking pin (B) is difficult to release, turn knob (C) slightly clockwise to release locking pin (B) tension.

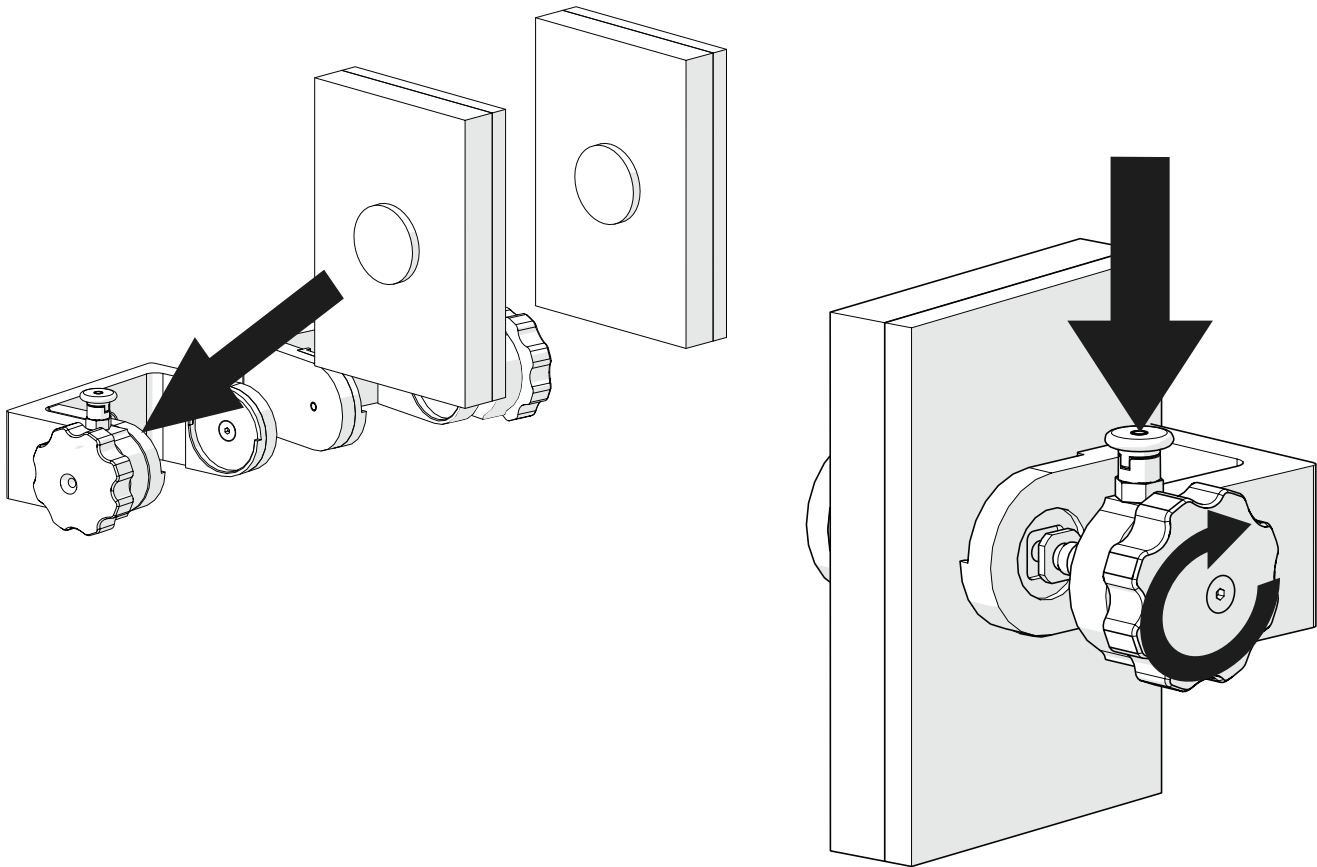

Figure 6. Schematic showing how to insert well plate adapters.

WARNING: Do not force locking pin (B) open. Turn knob (C) clockwise to release.

WARNING: The Bead Ruptor™ 96+ only accepts SBS format plates less than 49.25 mm high.

WARNING: Well plates and adapters must be inserted and aligned with centering points (A). If this is not done the well plates may be ejected during processing.

WARNING: Milling arms must be balanced prior to operation. You must always operate with two well plate adapters. One in each arm.

Setting the Homogenization Frequency

By pressing the FREQUENCY button, you can set the homogenization frequency. The button lights up.

Set new frequency by rotating the knob and confirm it by pressing on the knob. The button light will then turn off.

NOTE: After 5 seconds of inactivity, the setting is automatically canceled.

You can set the frequency from 3.0 to 30 Hz.

Frequency setting from 3.0 to 9.9 Hz is possible in 0.1 Hz steps.

Between 10 and 30 Hz the setting is possible in 1 Hz steps.



NOTE: You can change the homogenization frequency during the operation of the instrument, which starts to work with the new frequency after that. After 5 seconds of inactivity, the setting is automatically canceled.

Setting the Run Time

By pressing the TIME button, you can set the run time. The button lights up.

Set new time by rotating the knob and confirm it by pressing on the knob. The button light will then turn off.

NOTE: After 5 seconds of inactivity, the setting is automatically canceled.

You can set the time from 10 seconds (0.10) to 99 minutes 50 seconds (99.5).

Time setting from 0.10 to 9.59 minutes is possible in 1 second steps.

Between 10.0 and 99.5 minutes the setting is possible in 10 second steps.

NOTE: 0.10 = 10 s, 9.59 = 9 min 59 s, 10.0 = 10 min, 99.5 = 99 min 50 s



By rotating the knob clockwise after 99.5 is displayed, or counterclockwise after 0.10 is displayed, you can set continuous operation (HLd on display).

NOTE: The time can't be changed during operation. You can only check the set time by pressing the TIME button. By pressing on the knob, you return to current time. This also happens automatically after 5 seconds.

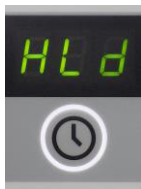

Program Setting

You can save 99 programs, with different operational parameters, in the instrument memory. If you select two lines (--), it means that no program is set. By entering the program setting, the cyclor turns off automatically, if it was set (see next chapter).

NOTE: You can cancel the procedure for program setting by pressing the STOP button and return to stand-by mode without confirming the data. Operation parameters are reset to the last used values before using the program.

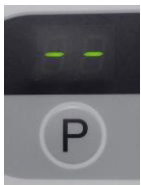

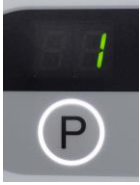

If you want to use the existing program:

By pressing the PROGRAM button, you can set the programs. The button lights up. Select a program by rotating the knob and confirm it by pressing on the knob. The button light will then turn off. Operation parameters set in selected program will be displayed



If you want to change the existing program:

By pressing the PROGRAM button, you can set the programs. The button lights up. Select the program that you want to change, by rotating the knob. While the PROGRAM button is lit, set the values of individual operational parameters (homogenization frequency and run time), using the procedures described in the previous sections. Once you set the values of individual operational parameters, confirm it by pressing the knob. The light for the PROGRAM button will then turn off. Operation parameters set in selected program will be displayed. You can't use cycler in the programs. If you want to change another program, select it by rotating the knob, and set the values of individual operation parameters for this program. Otherwise skip this step.

Program Number	Run Time (min)	Homogenization Frequency (Hz)
1	0:30	20
2	0:30	30
3	1:00	20
4	1:00	30
5	1:30	20
6	1:30	30
7	2:00	20
8	2:00	30
9	2:30	20
10	2:30	30
11	3:00	20
....	3:00	20
99	3:00	20

Table 4. Run time and homogenization frequency parameters for available 99 programs.

Cycler Setting

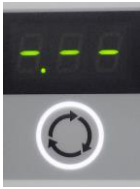

You can save up to 9 different cycler programs, with different operational parameters, in the instrument memory. Each cycle program can contain up to 9 cycles. Each cycle can be programmed with up to 9 different sub parameters. The sub parameters must be programmed in succession, one after another, with the next consecutive numbered sub parameter appearing only after the previous one has been programmed.

The purpose of the cycler setting is to allow for programming of repeated cycle sub parameters. For example, if cycle program 1 is selected and programmed to 3 cycles with 2 sub parameters consecutively set to "Sub parameter 1: process 1 minute at 25 Hz. Sub parameter 2: process 30 seconds at 0 Hz," the instrument will run 3 cycles each containing the 2 consecutive sub parameters set.



If you select three lines (---), it means that no cycler program is set. By entering the cycler setting, the program turns off automatically, if it was set (see previous chapter).

NOTE: You can cancel the procedure for cycler setting by pressing the STOP button and return to stand-by mode without confirming the data. Operation parameters are reset to the last used values before using the cycler.

If you want to use the existing cycler program:

By pressing the CYCLER button, you can set the cycler. The button lights up.

Select a cycler program (dot after first number) by rotating the knob and confirm it by pressing on the knob. The button light will then turn off. Operation parameters set in selected cycler program are shown on display.

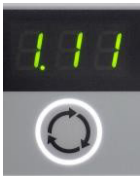

Cycle program (dot after first number)



Number of cycles (dot after second number)



Sub parameters per cycle (dot after third number)

Figure 7. Showing dot after first, second and third number in cycler.

If you want to view/change the existing program:



By pressing the CYCLER button, you can set the cyclers. The button lights up. Select a cycler program number you wish to change (dot after first number) by rotating the knob.



By pressing the CYCLER button a second time select the number of cycles (dot after second number). By rotating the knob set the number of cycles from 1 to 9.



Press the CYCLER button a third time to program each sub parameter (dot after third number) by rotating the knob. You must set the cycles in consecutive order starting at 1, programming each sub parameter until the desired number is reached. A maximum of 9 sub parameters can be programmed. Select sub parameter 1 and set the homogenization frequency and run time for sub parameter 1, using the procedures described in the previous sections.



If desired, then select sub parameter 2 by rotating the knob and set the homogenization frequency and run time for sub parameter 2.

NOTE: When programming sub parameters, you can set homogenization frequency also to 0 Hz, which is useful to dwell between cycles for cooling.



Repeat the previously described steps for the desired number sub parameters.

If you want to reduce the number of sub parameters, using the knob, set the values of homogenization frequency and run time operation parameters to lines (homogenization frequency (--), run time (---)).

Factory pre-set values of operation parameters for all 9 cycle programs are:

- Number of cycles: 1
- Run time for sub parameter 1: 1.00 min, sub parameter 2: 1.00 min, sub parameter 3: --- min
- Homogenization frequency for sub parameter 1: 10 Hz, sub parameter 2: 20 Hz, sub parameter 3: -- Hz

The three cycler scenarios described below are hypothetical examples created to help users fully understand the operating parameters of the cycler function on the Bead Ruptor 96+.

Note: Cycler Scenario # 1 and Cycler Scenario # 2 show two different ways to program the same operational parameters on the instrument using the cycler program. In both scenarios, the Bead Ruptor 96+ will perform 4 consecutive runs. Each of the 4 runs are identical in time and speed (time: 10 seconds, speed: 30 Hz).

Cyclor Scenario # 1

Program 1, 1 cycle, 4 sub parameters. The Bead Ruptor 96+ will run 1 cycle containing 4 sub parameters (each sub parameter programmed to run for 10 seconds at 30 Hz) in chronological order from sub parameter 1 through sub parameter 4.



Sub parameter 1: programmed to run for 10 seconds at 30 Hz. During each cycle, this sub parameter will run first.



Sub parameter 2: programmed to run for 10 seconds at 30 Hz. During each cycle, this sub parameter will run second.



Sub parameter 3: programmed to run for 10 seconds at 30 Hz. During each cycle, this sub parameter will run third.



Sub parameter 4: programmed to run for 10 seconds at 30 Hz. During each cycle, this sub parameter will run fourth.

Figure 8. Programming details for sub parameters 1-4 in Cycler Scenario # 1.

Cycler Scenario # 2

Program 2, 4 cycles, 1 sub parameter. The Bead Ruptor 96+ will run 4 cycles. Each of the 4 cycles will contain 1 sub parameter programmed to run for 10 seconds at 30 Hz.



Sub parameter 1: programmed to run for 10 seconds at 30 Hz. This is the only sub parameter programmed for each of the 4 cycles.

Figure 9. Programming details for sub parameter 1 in Cycler Scenario # 2.

Cycler Scenario # 3

Program 3, 2 cycles, 3 unique sub parameters. The Bead Ruptor 96+ will run 2 cycles. Each of the 2 cycles will contain 3 unique sub parameters: the first sub parameter programmed to run for 1 minute at 25 Hz, the second sub parameter programmed to dwell for 1 minute at 0 Hz and the third sub parameter programmed to run for 30 seconds at 30 Hz.



Sub parameter 1: programmed to run for 1 minute at 25 Hz. During each cycle, this sub parameter will run first.



Sub parameter 2: programmed to dwell for 1 minute at 0 Hz. During each cycle, this sub parameter will run second.



Sub parameter 3: programmed to run for 30 seconds at 30 Hz. During each cycle, this sub parameter will run third.

Figure 10. Programming details for sub parameters 1-3 in Cycler Scenario # 3.

Starting and Stopping the Unit

Before starting the instrument, turn on the main switch, open the lid, insert the milling jars, close the lid and set the operation parameters or select a suitable program or cyclor program.

By pressing the START button, you start the run of the instrument. The button lights up and thus indicates that the instrument is running. The instrument counts down the time from set value. You can't change the time during the operation of the instrument. If continuous operation "HLd" is set, the instrument is running until you stop it manually by pressing the STOP button.



After the expiration of set run time or after manual stopping, the instrument stops. The next run is possible when the instrument stops completely.

By pressing the STOP button, you stop the run of the instrument. The button lights up and thus indicates that the instrument is stopping. Until the instrument stops completely, START button is lit, thus indicating that the instrument hasn't stopped yet, and message "End" is displayed on time display.



When the instrument stops, only STOP button is lit and the last used values for time and frequency are automatically set.



Operational Best Practices

Recommended Jar Filling Levels

Recommended values are indicated, but due to the different samples and milling conditions, minor deviations are permitted.

Milling Jar Volume	Recommended Milling Jar Sample Amount	Maximum Sample Grain Size	Maximum Milling Balls Diameter
25 mL	10 mL	6 mm	15 mm
50 mL	20 mL	8 mm	25 mm

Recommended Frequencies and Timing

If you are using the instrument at frequencies above 20 Hz, it is recommended that run times are not longer than 10 minutes. Otherwise overheating of the jars and instrument parts may occur, which may lead to damaging of the jars and/or instrument. If 10-minute runs at 20 Hz or above are not enough, then you should consider pre-treatment to the sample, like cooling it with liquid nitrogen.

If these measures are not applicable, the milling should be done in several runs of 10 minutes or less, with long enough pauses in-between (at least 5 minutes) to provide for cooling time.

Cooling with Liquid Nitrogen







Materials that are difficult to mill at normal temperatures must be milled cold.

Pre-embrittlement with liquid nitrogen improves the fracture behavior of elastic and tough sample materials like thermoplastics, rubber products, fatty foods, pharmaceuticals, etc. Pre-embrittlement of sample materials must be done indirectly. Use only milling jars and milling balls made of stainless steel or hardened steel for cooling with liquid nitrogen. The sample materials must be filled into milling jars together with the milling balls and then the milling jars must be tightly closed. Then immerse the tightly closed milling jars with appropriate tools in a bath of liquid nitrogen until it stops bubbling. Then the sample materials inside the milling jars are also cooled and ready for milling.

WARNING: Always wear protective gloves and goggles when working with liquid nitrogen. Liquid nitrogen has a temperature of -196°C and will cause severe burns and frostbite with skin or eye contact.

Milling Jar Usage and Washer Replacement

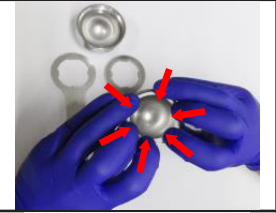
The following procedure shows an example for preparing and using of one milling jar. As you always must use two milling jars, use the same procedure also for the second milling jar.

<p>There are two special wrenches included with the Bead Ruptor 96+, which are used for tightening and loosening of milling jars, when replacing the samples and the milling balls.</p>	
<p>To open the milling jar, take one key in the hand, and insert one end of the milling jar into it, so that the grooves fit. Then take the other key and place it on the other end of the milling jar. To loosen the milling jar, turn the upper key in counterclockwise direction to loosen it.</p>	
<p>When the milling jar is loose, put down the upper key, and use the hand to unscrew the milling jar completely.</p>	
<p>Open the milling jar. If you need to replace the washer, follow the next two steps, otherwise skip them.</p>	
<p>Follow this step only when replacing the washer. There is a PTFE washer in the groove of contact surface on one side of the milling jar. If the washer becomes worn out, damaged, or the milling jar is leaking, you must replace the washer immediately. Please take it out with your fingers. NOTE: We recommend replacing the washer every 100 closures / openings of the milling jar.</p>	
<p>Follow this step only when replacing the washer. Take a new washer and insert it in the groove on one side of the milling jar. Put your fingers around the washer and push it down in the groove, until it fits in.</p>	
<p>Fill the milling jar with your sample and milling balls and use your hands to screw the milling jar together by turning the upper part in clockwise direction, until it stops.</p>	
<p>Use the keys to firmly tighten the milling jar by turning the upper key in clockwise direction.</p>	

Troubleshooting

Main switch is not lit, when it is switched ON.	Check the mains power supply. Check fuses and replace them, if necessary. Call authorized service.
Displays don't work.	Call authorized service.
Message "Er Lid oPE Er" appears on displays.	The lid was open when you tried to start the instrument by pressing the START key. Close the lid and clear the message by pressing the START key. Then you can start the instrument by pressing the START key again.
Message "Er Lid Err Er" appears on displays.	You opened the lid during the operation. The instrument stopped rapidly and message "Er Lid Err Er" appeared on displays. When this message appears on displays, you can't start the instrument again by pressing the START key. You have to turn the main switch OFF and then ON again, to clear the message and use the instrument again.
Message "Er mot tE Er" appears on displays.	Motor overheated. Turn the main switch OFF and wait for the motor to cool down. Reduce the load of the instrument.
Message "Er oVE LoA Er" appears on displays.	The instrument can't reach the set vibrational frequency in five attempts. After the fifth attempt, the instrument stops and message "Er oVE LoA Er" appears on displays. Possible causes are: 1. When using the largest and heaviest milling jars, balls and samples at maximum vibrational frequencies, overload and stopping of the instrument may occur. In this case, reduce the vibrational frequency a little, so that the instrument will function normally. 2. Check if the milling jar holders are blocked and remove any obstacle. 3. Mechanism inside the instrument is damaged. Solution: Turn the main switch OFF and then ON again, to clear the error message and use the instrument again. If this error is repeated, even when you reduce the vibrational frequency below 20 Hz, call authorized service.
Message "Er HAL SEn Er" appears on displays.	Speed sensor error. Call authorized service.
Message "Er VoL Hi Er" appears on displays.	Voltage too high. Call authorized service.
Message "Er VoL Lo Er" appears on displays.	Voltage too low. Call authorized service.
Message "Er Cu Hi Er" appears on displays.	Current overload. Turn the main switch OFF and then ON again, to clear the error message and reduce the load of the instrument. Call authorized service.
Message "Er tEm Hi Er" appears on displays.	Driver temperature too high. Turn the main switch OFF and wait for the driver to cool down. Reduce the load of the instrument. Call authorized service.

NOTE: When any error message, except "Er Lid oPE Er", appears on displays, instrument stops automatically, and you can't start it again by pressing the START key. You have to turn the main switch OFF and then ON again, to clear the error message and use the instrument again.

Maintenance

When used properly the Bead Ruptor 96+ doesn't need a lot of maintenance or adjustments. Do not make any alterations to the instrument and use only approved spare parts and accessories.

If you disregard the recommended maintenance, some problems may occur, like overheating of the bearings and milling jars, leakages, staining, deformations and thus sluggishness of the threads on the milling jars. All these problems may lead to shortening of the instrument's lifespan.

The milling tools can become worn out, depending on the frequency of the milling operation and the milled material. The milling jars, washers and balls should be regularly checked for wear, mechanical damage, cracks, corrosion, and replaced, if necessary.

Cleaning the Instrument

For cleaning of the device housing, use a soft cloth moistened with water. If necessary, you can also use a standard non-abrasive household cleaning detergent. Make sure, that no water or detergent gets inside of the instrument. You can also use a vacuum cleaner.

Cleaning the Milling Jars and Balls

For cleaning of the milling jars and balls, you can use a soft cloth moistened with water. But for better cleaning we recommend the use of the cleaning and degreasing solution TEKTON. You can also clean the milling jars and balls in a dishwasher.

For cleaning of the milling jars, especially of the threads, we recommend the use of a brush and the product TEKTON. We recommend the use of the following brushes. Nylon wire brush: for cleaning of minor impurities. Brass wire brush: for cleaning of medium impurities. Steel wire brush: for cleaning of major impurities.

Cleaning process:

Before cleaning remove the washer from the milling jar and clean it separately.

Spray the product TEKTON on the milling jar and leave it to take effect for 3 to 15 minutes.

Then use a nylon wire brush for cleaning. When cleaning the threads, move the brush in the direction of the threads.

If you can't remove the impurities with nylon wire brush, use brass wire brush. If you can't remove the impurities even with brass wire brush, then use steel wire brush, but be careful, not to damage the milling jar.

After cleaning, rinse the product TEKTON from the surfaces of the milling jar with warm clean water. Then wipe the milling jar with a clean soft cloth to dry it.

Repeat the cleaning process if necessary. After cleaning, insert the washer in the milling jar

WARNING: Wear protective gloves and eye protection when cleaning. If the product TEKTON comes in contact with the eyes, rinse them cautiously with water for several minutes. If eye irritation persists, seek medical attention or care.

Replacing Fuses



The following fuses are required for Bead Ruptor 96+:
2 x 3.15AT 250V (230V)
2 x 6.3AT 250V (120V)

- Unplug the mains plug from the mains socket 2.
- By pressing the locking device on the bottom side of the fuse compartment 1, fuse holder is released and you can pull it out.
- Replace fuses.
- Insert fuse holder and push it, until it locks.

Accessories

Part Number	Description
27-004	25 mL Milling Jars & O-Rings (2/pk)
27-006	50 mL Milling Jars & O-Rings (2/pk)
27-203	10 mm Milling Balls (10/pk)
27-206	25 mm Milling Balls (5/pk)
27-250	Milling Jar Wrenches (2/pk)
27-101	Bead Ruptor™ 96 Well Plate Adapters (2/pk)
27-106	Microtube or Screw Cap Tube Holders (2/pk)
27-107	96-Well 2D Barcoded Storage Tube Adapter for Micronic and FluidX Tubes
27-108	96-Well 2D Barcoded Storage Tube Adapter for Thermo Matrix, Micronic and FluidX Tubes
19-6001	2 mL Stainless Steel Lysing/Grinding Cryo Tube
27-1003	50 mL Tube Holders (2/pk)
19-900S	Active Grinding Media (50/pk)
19-6650	50 mL Tubes with Screw Caps (100/pk)

Appendix

Equipment Decontamination

If infectious materials get on the machine, milling jars or accessories, they must be appropriately decontaminated. They may only be decontaminated by hand with soft cloth and liquids, which contain the following ingredients: ethanol, n-propanol, ethyl hexanol. After using disinfectants, remove the disinfectant residue by wiping it with a damp cloth. The surfaces must be dried immediately after disinfecting. You must perform the decontamination before the machine is shipped to the service and before it is sent to disassembly after the end of the life cycle.

Transport and Storage

Transport and storage are only allowed in the original packaging. Remove the milling jars from the machine before transport and storage. The machine is heavy. To prevent possible injuries, be careful when lifting and carrying the machine. Use a transport aid for transferring the machine.

Permissible environmental conditions for transport and storage of the equipment:

- Temperature from - 25 °C to 60 °C
- Relative humidity 10 % to 75 %

Equipment Disposal

This equipment is marked with the crossed-out wheeled bin symbol, to indicate that this equipment may not be disposed of as unsorted municipal waste.

It's your responsibility to correctly dispose of your equipment at life-cycle end, by handing it over to an authorized facility for separate collection and recycling of waste equipment. It's also your responsibility to decontaminate your equipment in case of biological, chemical or radiological contamination, and so protect the persons involved in the disposal and recycling of the equipment from health hazards. For more information about where you can dispose of your waste equipment, please contact your local dealer, from whom you purchased the equipment. By doing so, you will help to preserve natural and environmental resources and you will ensure that your equipment is recycled in a manner that protects human health.



This page left blank intentionally.



The information provided in this document is for reference purposes only and may not be all-inclusive. Revvity, Inc., its subsidiaries, and/or affiliates (collectively, "Revvity") do not assume liability for the accuracy or completeness of the information contained herein. Users should exercise caution when handling materials as they may present unknown hazards. Revvity shall not be liable for any damages or losses resulting from handling or contact with the product, as Revvity cannot control actual methods, volumes, or conditions of use. Users are responsible for ensuring the product's suitability for their specific application. REVVITY EXPRESSLY DISCLAIMS ALL WARRANTIES, INCLUDING WARRANTIES OF MERCHANTABILITY OR FITNESS FOR A PARTICULAR PURPOSE, REGARDLESS OF WHETHER ORAL OR WRITTEN, EXPRESS OR IMPLIED, ALLEGEDLY ARISING FROM ANY USAGE OF ANY TRADE OR ANY COURSE OF DEALING IN CONNECTION WITH THE USE OF INFORMATION CONTAINED HEREIN OR THE PRODUCT ITSELF.

www.revvity.com

revvity

For research use only. Not for use in diagnostic procedures.

Revvity, Inc.
940 Winter Street
Waltham, MA 02451
USA
www.revvity.com

For a complete listing of our global offices, visit www.revvity.com
Copyright ©2024, Revvity, Inc. All rights reserved.