

The Revvity logo is displayed in white lowercase letters on a black background. To the right of the logo is a decorative graphic consisting of several overlapping, translucent spheres in shades of yellow, orange, and green, resembling a molecular structure or a cluster of beads.

revvity

USER MANUAL

Bead Ruptor 24TM

Bead Mill Homogenizer

Version: F **Date: October 2024**
Document Number: 03-241C

Data herein has been verified and validated. It is believed adequate for the intended use of the instrument. If the instrument or procedures are used for purposes over and above the capabilities specified herein, confirmation of the validity and suitability should be obtained; otherwise Revvity does not guarantee results and assumes no obligation or liability. This publication is not a license to operate under, or a recommendation to infringe upon, any process patents.

This product is warranted to be free from defects in material and workmanship for a period of ONE YEAR from the date of delivery. Revvity will repair or replace and return free of charge any part which is returned to its factory within said period, transportation prepaid by user, and which is found upon inspection to have been defective in materials or workmanship. This warranty does not include normal wear from use; it does not apply to any instrument or parts which have been altered by anyone other than an employee of Revvity nor to any instrument which has been damaged through accident, negligence, failure to follow operating instructions, the use of electric currents or circuits other than those specified on the plate affixed to the instrument, misuse, or abuse. Revvity reserves the right to change, alter, modify, or improve any of its instruments without any obligation whatever to make corresponding changes to any instrument previously sold or shipped.

THE FORGOING OBLIGATION IS IN LIEU OF ALL OBLIGATIONS AND LIABILITIES INCLUDING NEGLIGENCE AND ALL WARRANTIES OF MERCHANTABILITY OR OTHERWISE, EXPRESSED OR IMPLIED IN FACT OR BY LAW, AND STATE OUR ENTIRE AND EXCLUSIVE LIABILITY AND BUYERS EXCLUSIVE REMEDY FOR ANY CLAIM OF DAMAGES IN CONNECTION WITH THE SALE OR FURNISHING OF GOODS OR PARTS, THEIR DESIGN, SUITABILITY FOR USE, INSTALLATION, OR OPERATION. REVVITY WILL IN NO EVENT BE LIABLE FOR ANY SPECIAL OR CONSEQUENTIAL DAMAGES WHATSOEVER, AND THEIR LIABILITY UNDER NO CIRCUMSTANCES WILL EXCEED THE CONTRACT PRICE FOR THE GOODS FOR WHICH LIABILITY IS CLAIMED.

This product has been engineered for safety; however, basic safety precautions and common sense must always be demonstrated when using any electrical product.

- Use this product only for its intended purpose.
- Keep this product away from heated surfaces.
- **DO NOT** attempt to modify any part of this product.
- **DO NOT** allow the machine to be submerged in any liquid.
- **DO NOT** use in any setting other than an indoor laboratory.
- **DO NOT** use attachments not recommended by the manufacturer.
- **DO NOT** operate the product if it is damaged in any way.
- **DO NOT** operate the product with the safety ground disconnected.
- **DO NOT** modify the plug or cord that is provided.

WARNING: Reduce the risk of unintentional starting; make sure the machine is OFF before plugging into a power supply.

WARNING: Damaged or worn power cords should be repaired or replaced immediately by a qualified electrician.

WARNING: Improper connection of the equipment can result in a risk of electric shock.

Copyright

This manual is published by Revvity 935 Cobb Place Blvd, Kennesaw, GA 30144 USA. Copyright Revvity, Inc. All rights reserved, including but not limited to those rights to reproduce this publication or parts thereof. Reproduction of this publication or parts thereof, or the products it describes, by any means or in any form is expressly prohibited without the written permission of Revvity.

Trademarks

Revvity is a registered trademark of Revvity. All other trademarks are the property of their respective owners.

Proper Equipment Operation

To reduce the risk of electric shock, do not remove the cover. No user serviceable parts are inside. Refer to qualified service personnel if help is required. Use this product only in the manner described in this manual. If the equipment is used in a manner not specified by the manufacturer, the protection provided by the equipment may be impaired.

FCC

This device complies with part 15 of the FCC (United States Federal Communications Commission) Rules. Operation is subject to the following two conditions:

- This device may not cause harmful interference
- This device must accept any interference received, including interference that may cause undesired operation.

CE/UKCA

This device complies with all CE and UKCA rules and requirements.

Changes or modifications to this equipment not expressly approved by the party responsible for compliance could void the user's authority to operate the equipment.

WARNING: The Bead Ruptor 24™ Bead Mill unit weighs 65 lbs. (29 kg)

Improper handling of the unit can result in injury.

Always perform a Team Lift, when raising, lowering, or transporting the unit.

Team members working together to move the unit should follow the Lifting and Lowering guidelines provided below:

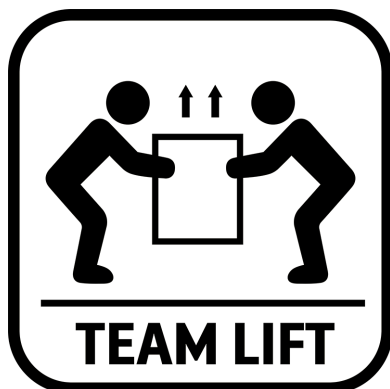

When Lifting from the Ground-Level:

- Position your body as close to the unit as possible.
- Bend your knees and squat down while keeping your torso upright.
- Using both hands, grab and support the unit from underneath and use your legs to slowly lift the unit up, while keeping your back straight.











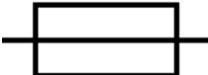

When Lowering to the Ground-Level:

- Position your body as close to the unit as possible.
- Using both hands, grab and support the unit from underneath.
- While keeping your back straight, carefully lift the unit up and clear it away from the resting surface.
- Bend your knees and squat down with the unit while keeping your torso upright.
- Slowly position the unit onto the ground, while being careful not to pinch your fingers underneath.

Table of Contents

Table of Symbols.....	5
Specifications.....	6
Site Requirements.....	6
System Overview.....	7
Voltage Selection.....	7
Loading Sample Tubes.....	8
General Operation.....	10
Getting Started.....	10
Language Setting.....	10
Programming Mode.....	11
Manual Programming.....	11
Run Time.....	12
Save Method.....	12
Troubleshooting.....	14
Appendix.....	15

Table of Symbols

Symbol	Description	Symbol	Description
	Caution. Refer to the User documentation (ISO 7000-0434B)		On (power). (IEC 60417-5007)
	Hazardous voltage; risk of electric shock. (IEC 60417-6042)		Off (power). (IEC 60417-5008)
	Fuse. (IEC 60417-5016)		Consult Instructions for Use. (ISO 7000-1641)
	Alternating current. (IEC 60417-5032)		CE Compliance Mark
	UKCA Certification Mark		WEEE symbol (EN50419:2005)
	RoHS Certification Mark		KC Certification Mark

Specifications

Part Number	19-070
Input Voltage	100-230V, 50/60 Hz
Weight	65 lbs. (29 kg)
Dimensions	W: 17" (43.2 cm), D: 15" (38.1 cm), H: 13" (33 cm)
Input Current	10A max
Power Connector	IEC 60320 C13
Fuse	6 x 30 mm / 4A max
Overvoltage Category	II
Pollution Degree	2
Altitude	Up to 2000 m
Warranty	1 Year
Standards Approval	CE and UKCA Approved

Site Requirements

The unit must be placed on a solid work surface. The work surface also requires a 15 amp circuit and only two units can be placed on this circuit at one time.

Weight and Dimensions

The work surface or bench must be able to support the weight of the system, i.e. 65 lbs. (29 kg).

The dimensions of the system are: with lid closed: L:15" (38.1 cm), W:17" (43.2 cm), H: 13" (33.0 cm) with lid open: L:15" (38.1 cm), W:17" (43.2 cm), H: 24.3" (61.6 cm).

Operating Environment

4°C to 40°C / 39°F to 104°F, Humidity: 5% to 95% RH

Ambient Air

The system must be located in an area where the ambient air is clean. No emission of solid particles or smoke in the air by adjacent equipment is allowed. The level of dust should be comparable to that of normal laboratory spaces.

Electrical Supply

19-070 120V, 50-60Hz, 10A max.

19-070 230V, 50-60Hz, 10A max.

Connect only to a properly grounded outlet.

External Fire Protection

External fire protection should be installed according to local regulations for equipment operating unattended.

System Overview

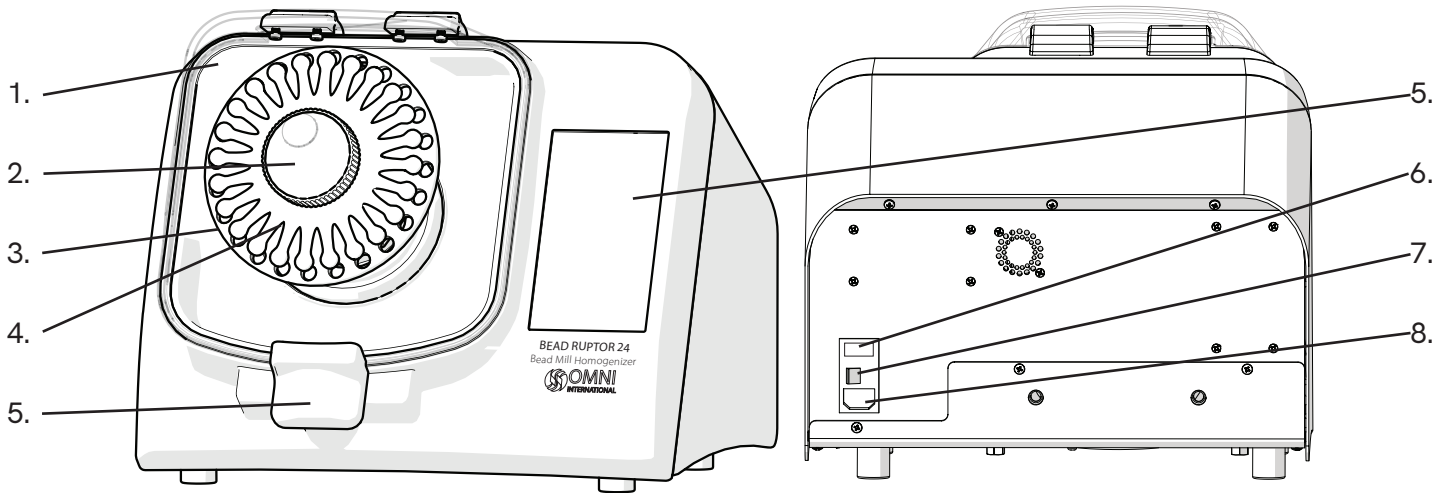

- 1. Lid
- 2. Drive Hub
- 3. Tube Carriage
- 4. Finger Plate

- 5. Lid Latch
- 6. Touch Screen
- 7. 115/220V Fuse
- 8. ON/OFF Switch

- 9. Power Cord Inlet

The Bead Ruptor 24™ consists of the following:

Description	Quantity
Bead Ruptor 24™	1
2 mL Finger Plate	1
Power Cords (US, EU, UK, AU)	EACH
Spare Fuse	1
User Manual	1

Voltage Selection

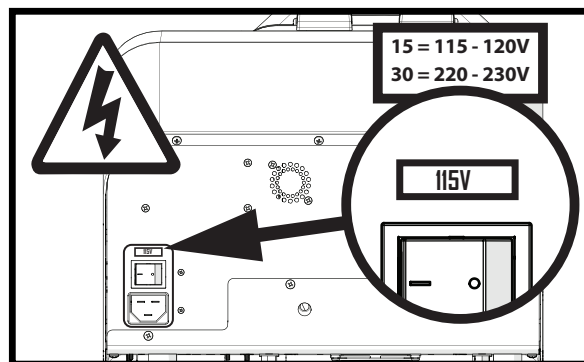

NOTE: Remove Warning stickers from the back of the unit and check that the voltage matches the voltage delivered by your electric power supply.

CAUTION: DO NOT connect the unit to the main power supply until correct voltage is selected. Then plug the unit into power supply using the appropriate power cord for your region.

CAUTION: If the voltage supplied to the unit is higher than what is indicated on the voltage switch, the electronics can be irreversibly damaged, voiding the warranty.

Loading Sample Tubes

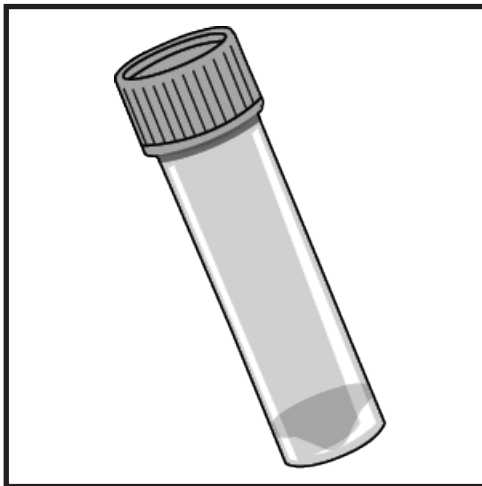
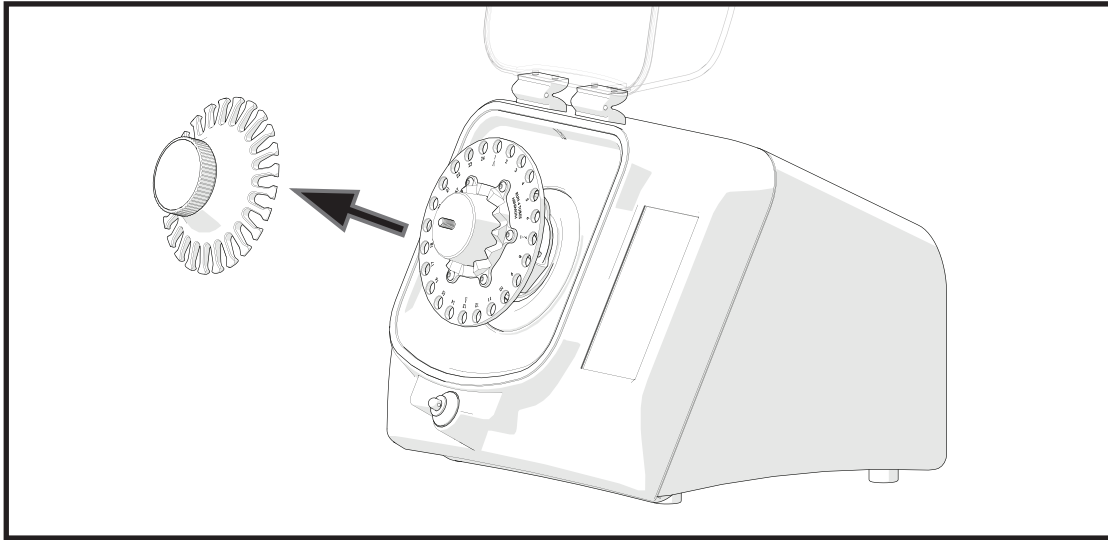

1. Fill tubes with material to be homogenized.

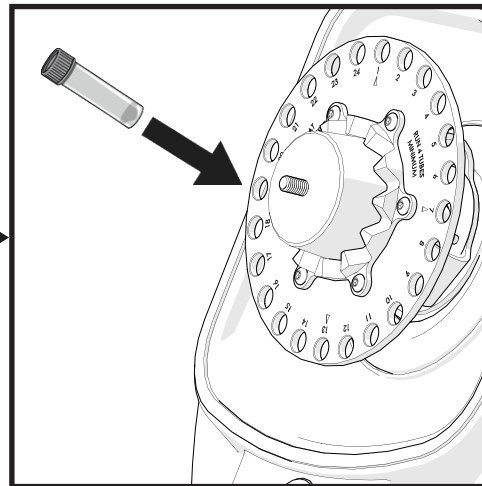

2. Load Tubes into the Tube Carriage Plate (See Figure 1).

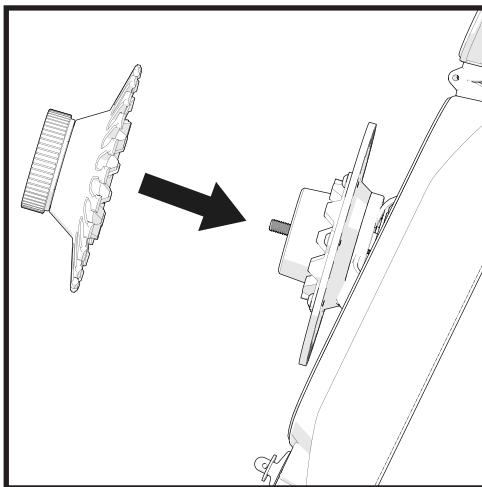

3. Place the Finger Plate on to the Tube Carriage Plate.

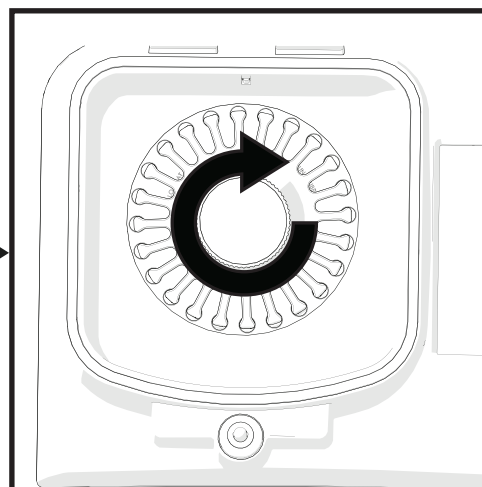

4. Turn handle clockwise until tight.

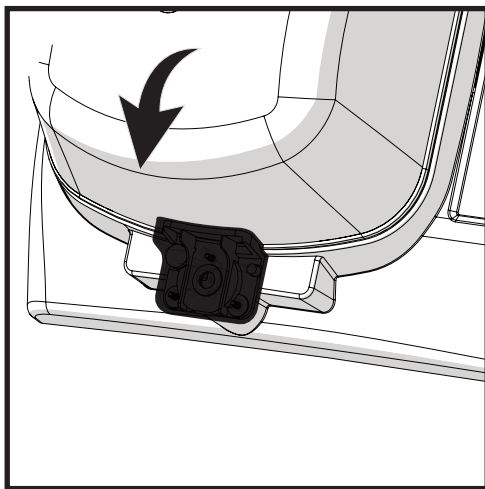
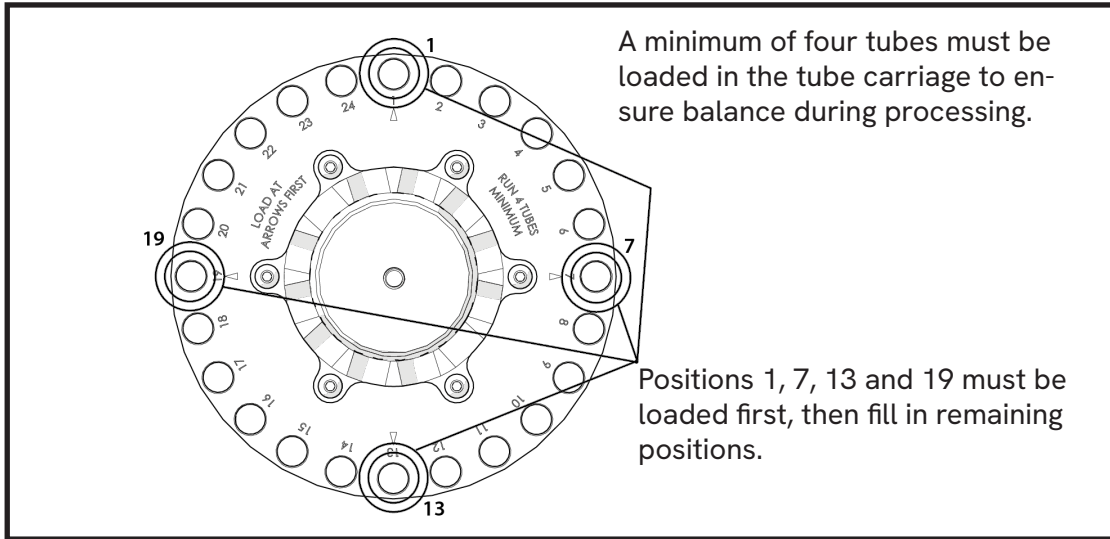

5. Close the lid until the locking handle clicks into place.
CAUTION: The unit will not run without the lid fully closed.

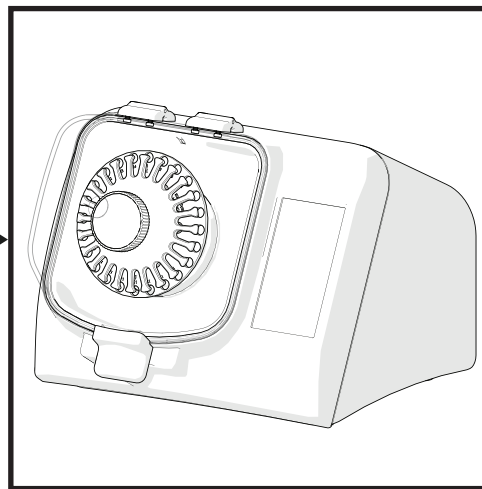

6. Begin processing cycle.

General Operation

Getting Started

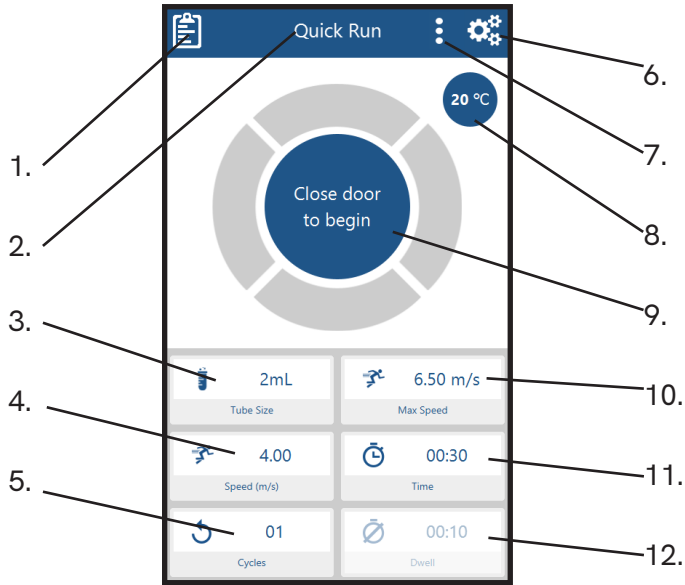

- | | |
|---------------------|---|
| 1. Menu | 6. Settings |
| 2. Method Name | 7. Edit Menu |
| 3. Tube Setting | 8. Processing Chamber Temperature |
| 4. Speed | 9. Run / Pause |
| 5. Number of Cycles | 10. Tube Speed Limit |
| | 11. Time Setting |
| | 12. Time Interval or Dwell Between Cycles |

Language Setting

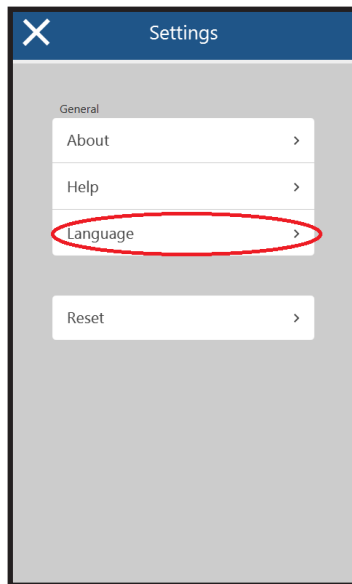

- Select Settings
- Select Language
- Choose from French, English, German, Italian, or Spanish

Programming Mode

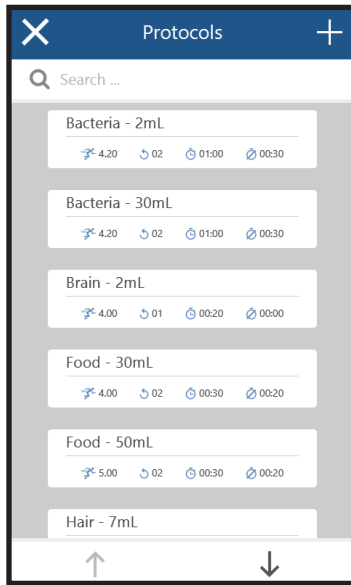

- Select Protocols
- Use search to find existing protocols or
- Press + to Create new Method

Manual Programming

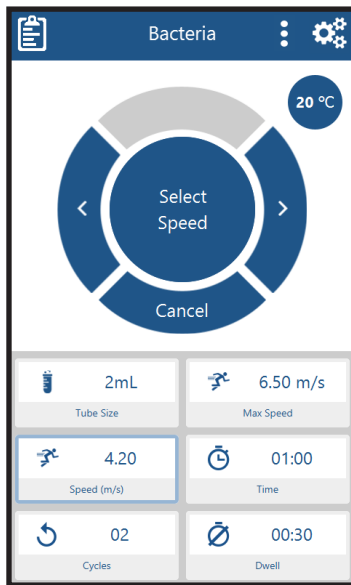

- Select homogenization parameter
- Adjust the parameter using < >
- Press OK to save the parameter

Parameter	Operating Range
Speed	0.8 m/s to 8 m/s
Time	0:01 to 9:59 in increments of 1 second
Number of Cycles	1 to 10
Dwell/Pause between runs	0:01 to 9:59 in increments of 1 second

Run Time



Save Method

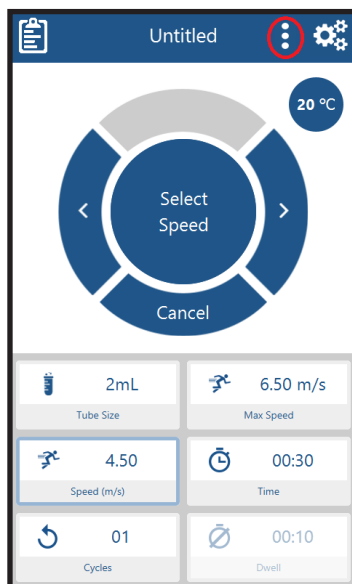

1. Select the Options Menu

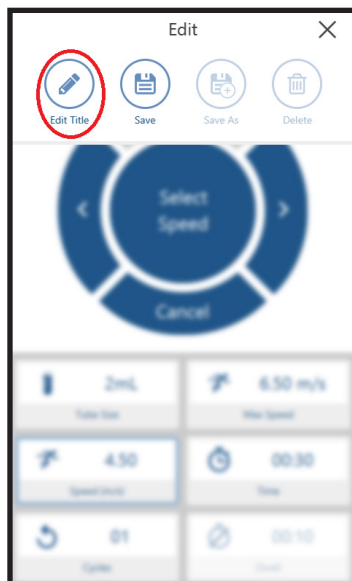

2. Select "Edit Title" in the Options Menu.

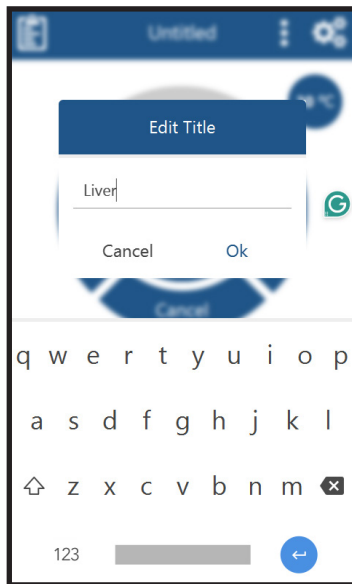

3. Enter a new title for the protocol and then press Ok.

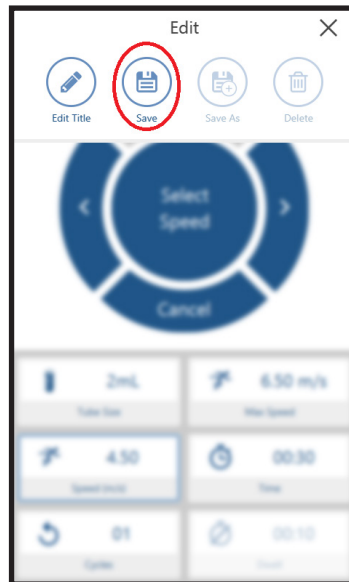
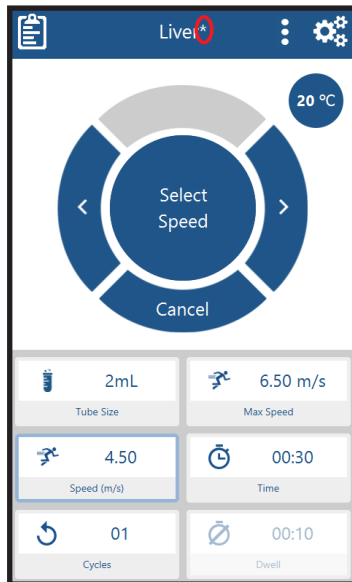

4. An asterisk after the title indicates that the Method has not been saved. Open the Options Menu and select "Save".

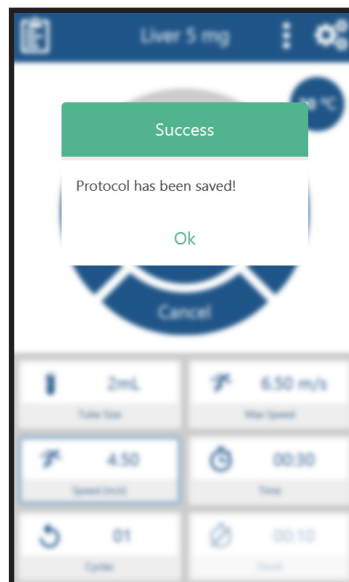
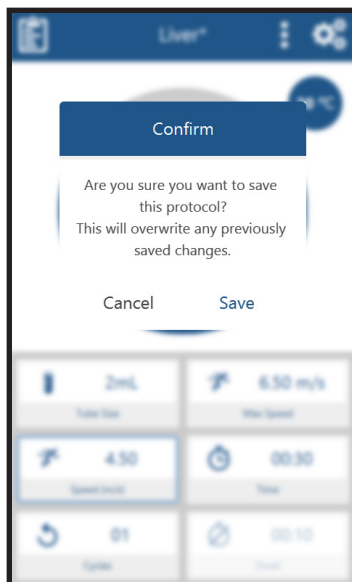

5. In the confirmation popup window, select "Save". A further popup confirms the Method saved successfully.

Troubleshooting

Error	Cause	Possible Solution
Unclosed Lid	The lid is not latched properly	<ol style="list-style-type: none"> 1. Check that nothing prevents the lid from closing. 2. Press lid and ensure the handle is locked properly.
	Detection system is faulty	<ol style="list-style-type: none"> 1. Turn off the unit. 2. Contact technical assistance.
Fan not working	No Power	<ol style="list-style-type: none"> 1. Check main voltage. 2. Check that the voltage of the unit matches that being delivered by the main power supply. 3. Make sure that the unit is plugged in properly. 4. Check and replace fuses if blown.
	Faulty Fan	<ol style="list-style-type: none"> 1. Turn off the unit. 2. Contact technical support.
Display screen shows incomplete or unusual characters	CPU needs to be reset	<ol style="list-style-type: none"> 1. Turn off the unit. 2. Wait 10 seconds. 3. Turn the unit back on.
No display on the screen	No Power	<ol style="list-style-type: none"> 1. Check main voltage. 2. Check that the voltage of the unit matches that being delivered by the main power supply. 3. Make sure the unit is plugged in properly. 4. Check and replace fuses if blown.
	Faulty display screen	<ol style="list-style-type: none"> 1. Turn off the unit. 2. Contact technical support.
One or several tubes are not sealed tightly	The cap is not properly sealed or the tube is faulty	If dangerous or potentially dangerous sample is contained in the tube, apply the proper decontamination procedure.
Unit powers on with a loud "BANG"	Motor control device damaged due to incorrect voltage selection	Return unit to Revvity for replacement of motor control device.
Unit powers on but motor does not turn	Incorrect voltage selected	Power off the unit and select appropriate voltage. If problem persists, contact Revvity for assistance.
Tube leakage	Speed is too high High temperature or pressure inside tubes	Reduce processing time or speed.

WARNING: Any service must be performed by a qualified service technician. This can be either an Revvity Technician or an end user resource.

All parts need to be sourced from the Revvity service department.

Appendix

This equipment is marked with the crossed-out wheeled bin symbol, to indicate that this equipment may not be disposed of as unsorted municipal waste.

It's your responsibility to correctly dispose of your equipment at life-cycle end, by handing it over to an authorized facility for separate collection and recycling of waste equipment. It's also your responsibility to decontaminate your equipment in case of biological, chemical or radiological contamination, and so protect the persons involved in the disposal and recycling of the equipment from health hazards.

For more information about where you can dispose of your waste equipment, please contact your local dealer, from whom you purchased the equipment.

By doing so, you will help to preserve natural and environmental resources and you will ensure that your equipment is recycled in a manner that protects human health.





The information provided in this document is for reference purposes only and may not be all-inclusive. Revvity, Inc., its subsidiaries, and/or affiliates (collectively, "Revvity") do not assume liability for the accuracy or completeness of the information contained herein. Users should exercise caution when handling materials as they may present unknown hazards. Revvity shall not be liable for any damages or losses resulting from handling or contact with the product, as Revvity cannot control actual methods, volumes, or conditions of use. Users are responsible for ensuring the product's suitability for their specific application. REVVITY EXPRESSLY DISCLAIMS ALL WARRANTIES, INCLUDING WARRANTIES OF MERCHANTABILITY OR FITNESS FOR A PARTICULAR PURPOSE, REGARDLESS OF WHETHER ORAL OR WRITTEN, EXPRESS OR IMPLIED, ALLEGEDLY ARISING FROM ANY USAGE OF ANY TRADE OR ANY COURSE OF DEALING IN CONNECTION WITH THE USE OF INFORMATION CONTAINED HEREIN OR THE PRODUCT ITSELF.

www.revvity.com

revvity

For research use only. Not for use in diagnostic procedures

Revvity, Inc.
940 Winter Street
Waltham, MA 02451
USA
www.revvity.com

For a complete listing of our global offices, visit www.revvity.com
Copyright ©2024, Revvity, Inc. All rights reserved.