

Vortex Mixer 24

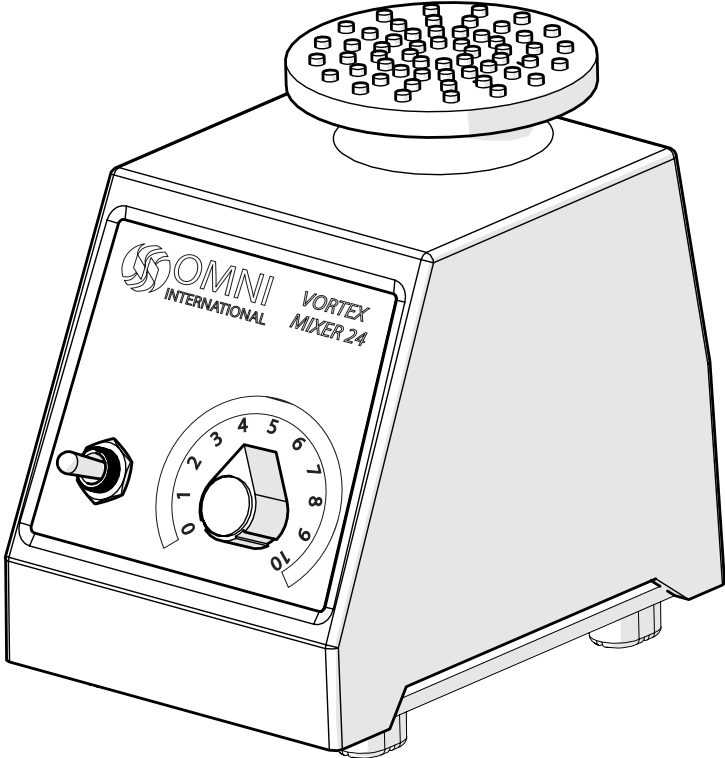

This page left blank intentionally.

Data herein has been verified and validated. It is believed adequate for the intended use of the instrument. If the instrument or procedures are used for purposes over and above the capabilities specified herein, confirmation of the validity and suitability should be obtained; otherwise Omni International does not guarantee results and assumes no obligation or liability. This publication is not a license to operate under, or a recommendation to infringe upon, any process patents.

This product is warranted to be free from defects in material and workmanship for a period of ONE YEAR from the date of delivery. Omni International will repair or replace and return free of charge any part which is returned to its factory within said period, transportation prepaid by user, and which is found upon inspection to have been defective in materials or workmanship. This warranty does not include normal wear from use; it does not apply to any instrument or parts which have been altered by anyone other than an employee of Omni International nor to any instrument which has been damaged through accident, negligence, failure to follow operating instructions, the use of electric currents or circuits other than those specified on the plate affixed to the instrument, misuse, or abuse. Omni International reserves the right to change, alter, modify, or improve any of its instruments without any obligation whatever to make corresponding changes to any instrument previously sold or shipped.

THE FORGOING OBLIGATION IS IN LIEU OF ALL OBLIGATIONS AND LIABILITIES INCLUDING NEGLIGENCE AND ALL WARRANTIES OF MERCHANTABILITY OR OTHERWISE, EXPRESSED OR IMPLIED IN FACT OR BY LAW, AND STATE OUR ENTIRE AND EXCLUSIVE LIABILITY AND BUYERS EXCLUSIVE REMEDY FOR ANY CLAIM OF DAMAGES IN CONNECTION WITH THE SALE OR FURNISHING OF GOODS OR PARTS, THEIR DESIGN, SUITABILITY FOR USE, INSTALLATION, OR OPERATION. OMNI INTERNATIONAL WILL IN NO EVENT BE LIABLE FOR ANY SPECIAL OR CONSEQUENTIAL DAMAGES WHATSOEVER, AND THEIR LIABILITY UNDER NO CIRCUMSTANCES WILL EXCEED THE CONTRACT PRICE FOR THE GOODS FOR WHICH LIABILITY IS CLAIMED.

This product has been engineered for safety; however, basic safety precautions and common sense must always be demonstrated when using any electrical product.

- DO NOT attempt to modify any part of this product.
- DO NOT allow the machine to be submerged in any liquid.
- DO NOT use in any setting other than an indoor laboratory.
- DO NOT plug power cord into an incorrect outlet or subject it to an incorrect voltage.
- Use this product only for its intended purpose.
- DO NOT use attachments not recommended by the manufacturer.
- DO NOT operate the product if it is damaged in any way.
- Keep this product away from heated surfaces.
- DO NOT modify the plug or cord that is provided. If the plug will not fit the outlet, have the proper outlet installed by a qualified electrician.
- DO NOT operate the product with the safety ground disconnected.

WARNING: Reduce the risk of unintentional starting; make sure the speed switch is in the OFF position before plugging in the motor.

WARNING: Damaged or worn power cords should be repaired or replaced immediately by a qualified electrician.

WARNING: Improper connection of the equipment can result in a risk of electric shock.

Overview

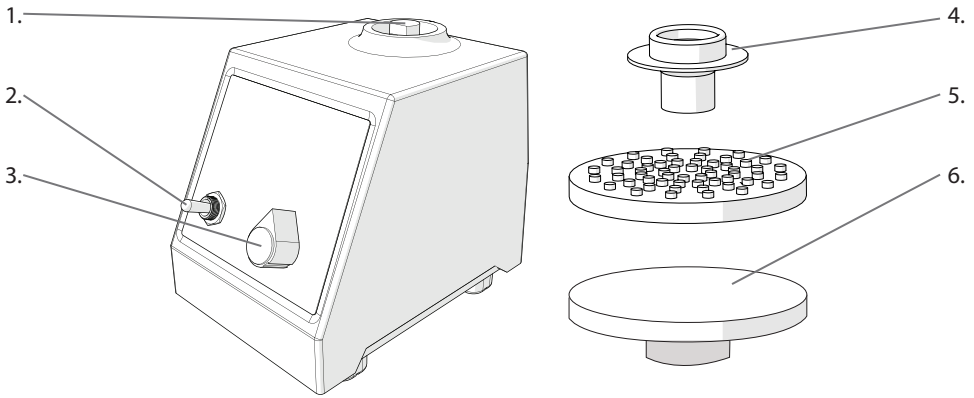

- 1. Hub
- 2. Power/Mode Switch
- 3. Speed Control Knob
- 4. Mixing Cup
- 5. Rubber Cover for 3" Mixing Platform
- 6. 3" Mixing Platform

The Vortex Mixer 24 consists of the following:

Description	Quantity
Vortex Mixer 24 Assembly	1
Mixing Cup	1
3 Inch Mixing Platform	1
Rubber Cover for 3 Inch Platform	1
User Manual	1

General Operation

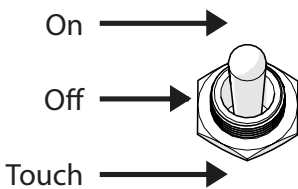

Power/Mode Switch

The Power/Mode Switch controls the Power and the operating mode of the Vortex Mixer 24.

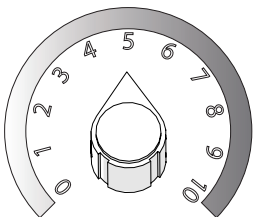

Speed Control Knob

Turn the Speed Control knob to the desired speed setting before starting. Most applications require a speed setting between 3 and 10 for mixing.

Accessories

3 Inch Mixing Platform

Align the flat portion of the Vortex Mixer 24's hub to the flat portion of the 3 inch mixing platform's receptacle. Press down until the attachment snaps into place.

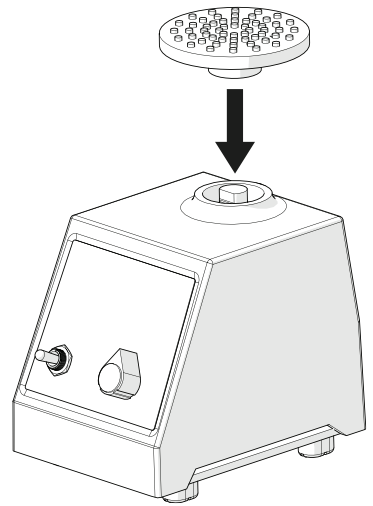

Mixing Cup

Align the flat portion of the Vortex Mixer 24's hub to the flat portion of the Mixing Cup's receptacle. Press down until the attachment snaps into place.

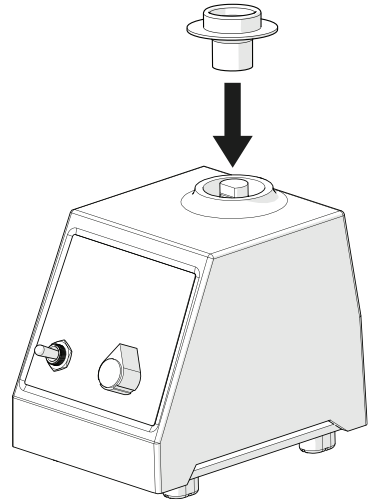

CAUTION: Turn the Power/Mode switch to the Off position before changing accessories.
CAUTION: Do Not lift the Vortex Mixer 24 by its attachment.
All attachments are removable.

Operation

Touch Mode

- Place the toggle switch in the TOUCH position and set the speed control to the desired setting.
- Press your processing vessel/s on the 3 Inch Platform or the Mixing Cup to begin mixing.
- Release the pressure to stop mixing.

Hands Free Mode

- Place the toggle switch ON position and set the speed control to the desired setting. The Vortex Mixer will run until turned to the off position.

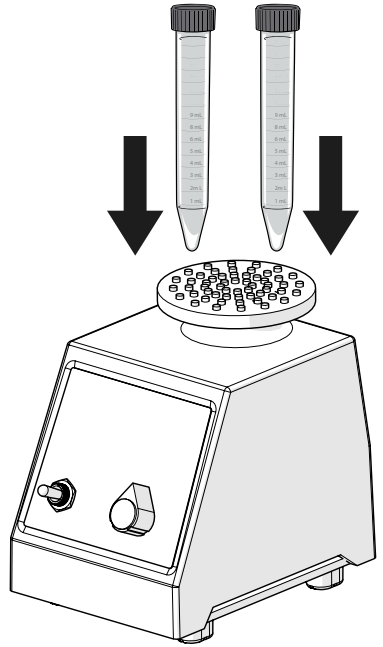
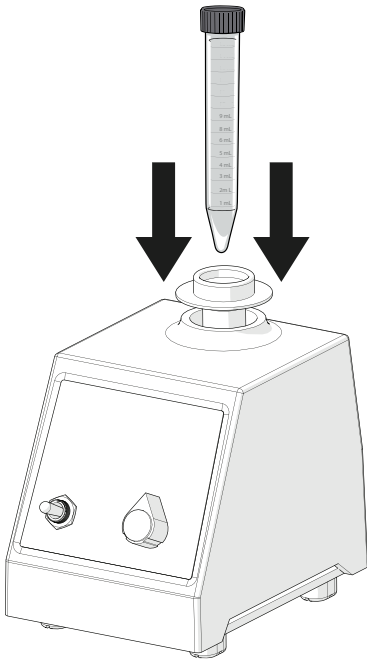

CAUTION: Unplug the Vortex Mixer 24 from its power source before cleaning. Do not submerge the unit in liquid.

This page left blank intentionally.



OMNI
International

935C Cobb Place Blvd.
Kennesaw, GA 30144
800.776.4431 • 770.421.0058
www.omni-inc.com